

INSTRUCTIUNI DE MONTAJ

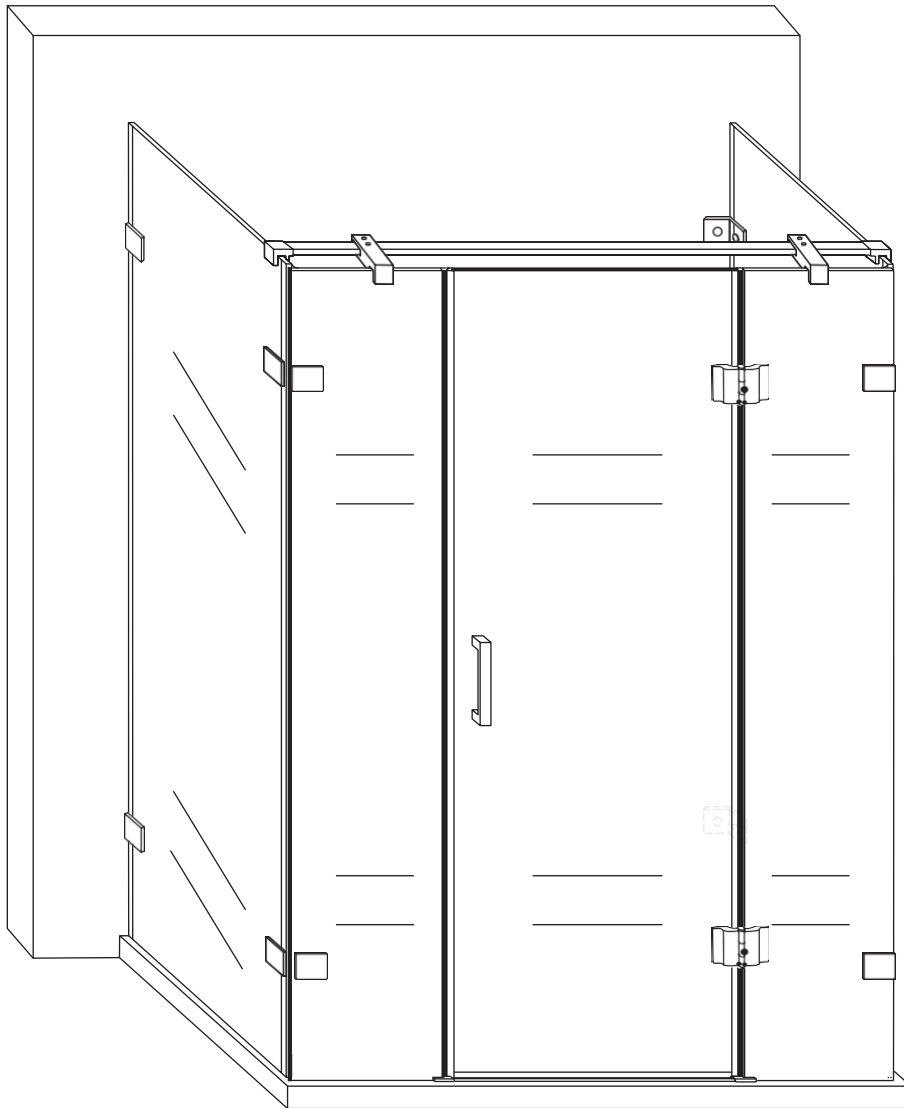

3017/3018/3019

RoHS **CE** **ISO 9001-2008**

Unelte necesare

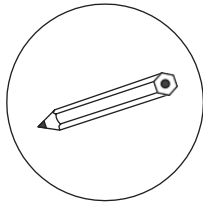

Creion

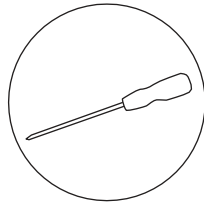

surubelnita

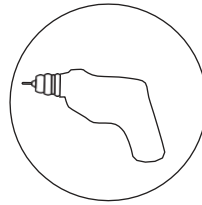

bormasina

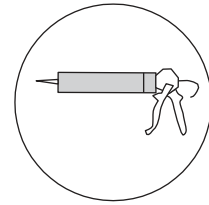

silicon

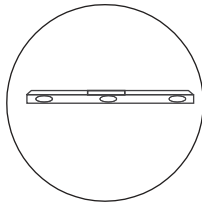

Boloboc

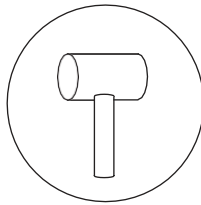

ciocan de cauciuc

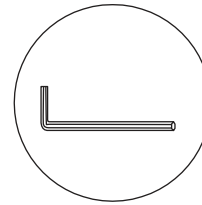

cheie hexagonala

LISTA

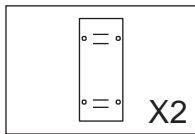

STICLĂ

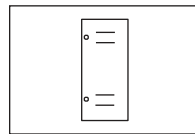

DE STICLĂ

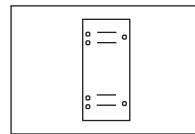

DE STICLĂ

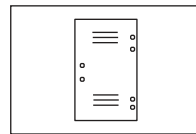

STICL
Ă

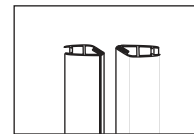

CT-8BMX90

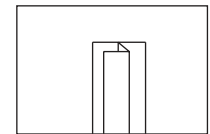

CT-8DST180

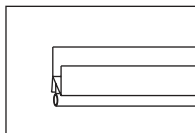

CT-8DSTQ

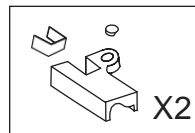

PY-4516

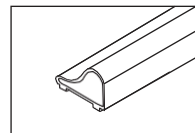

Aluminiu
Bara de jos

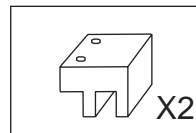

PY-4136

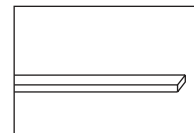

LG-2009

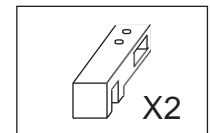

PJ-4151

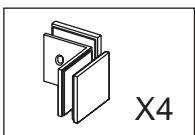

PY-4323

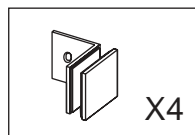

PY-4322

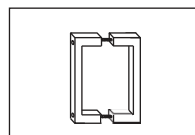

LS-1105

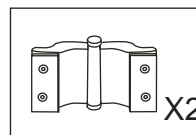

HY-3304

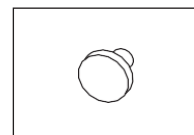

PY-4577

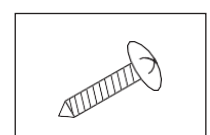

Șurub

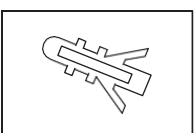

Extindeți
Tubul

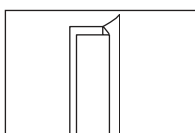

8B-1-12

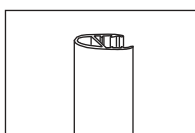

8B-5

Dimensiuni cabina	Profil	L1
1200X800	Vorbohrung	1096
1200X900	Vorbohrung	1096
1400X900	Vorbohrung	1296

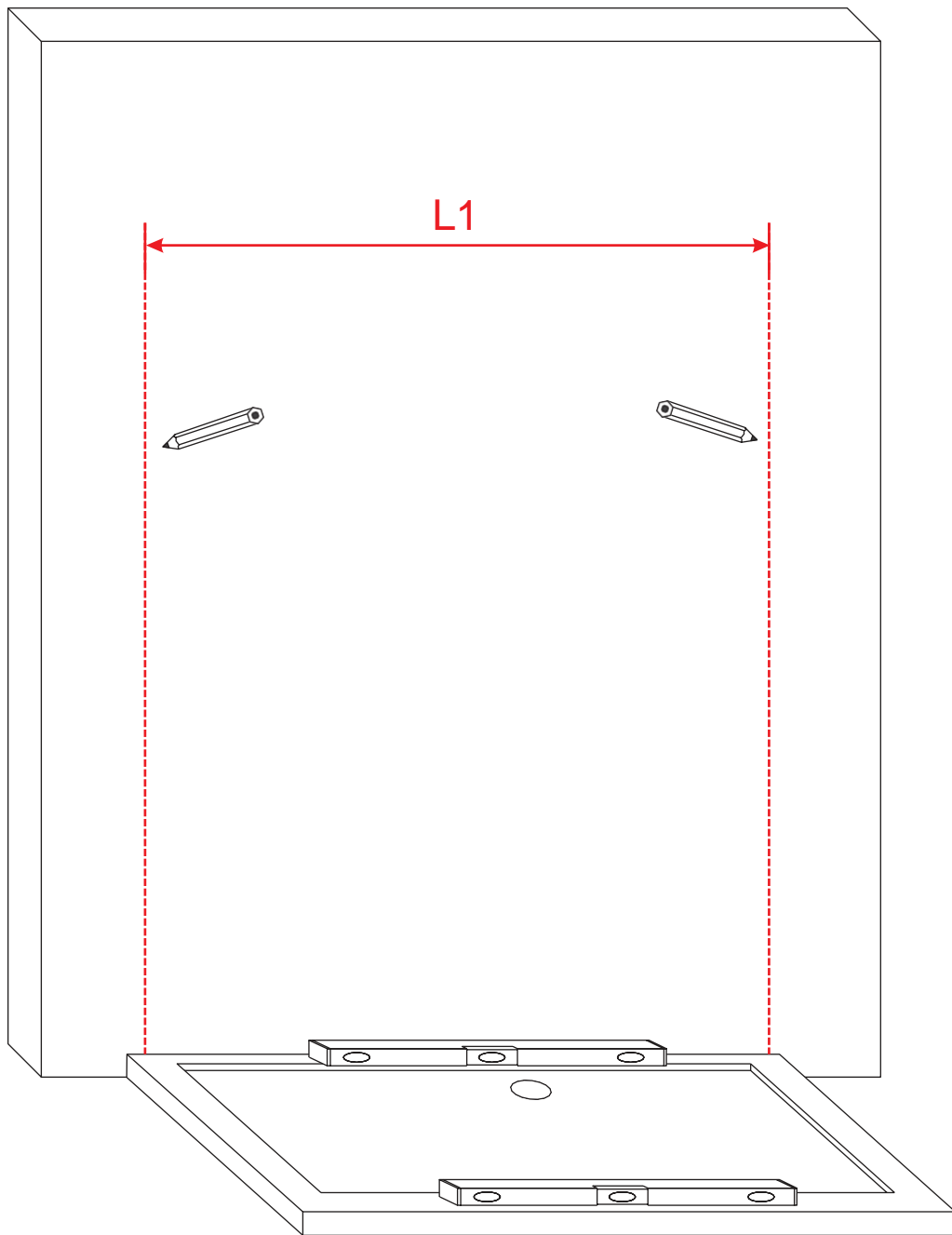

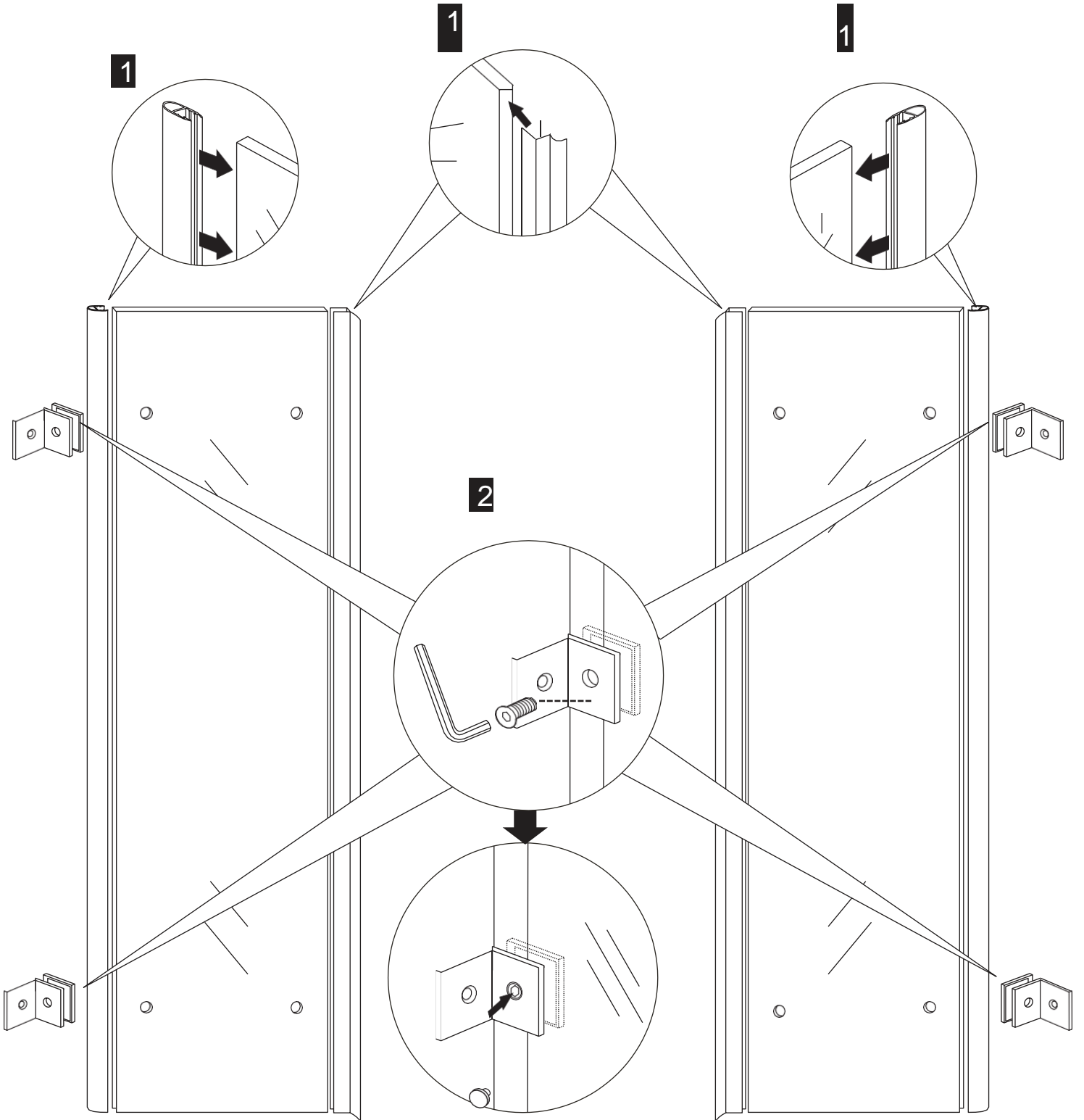
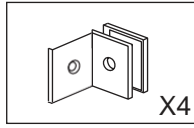
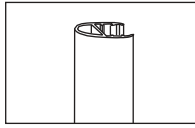
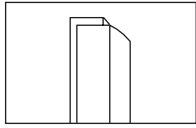
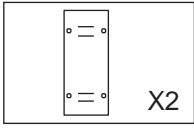

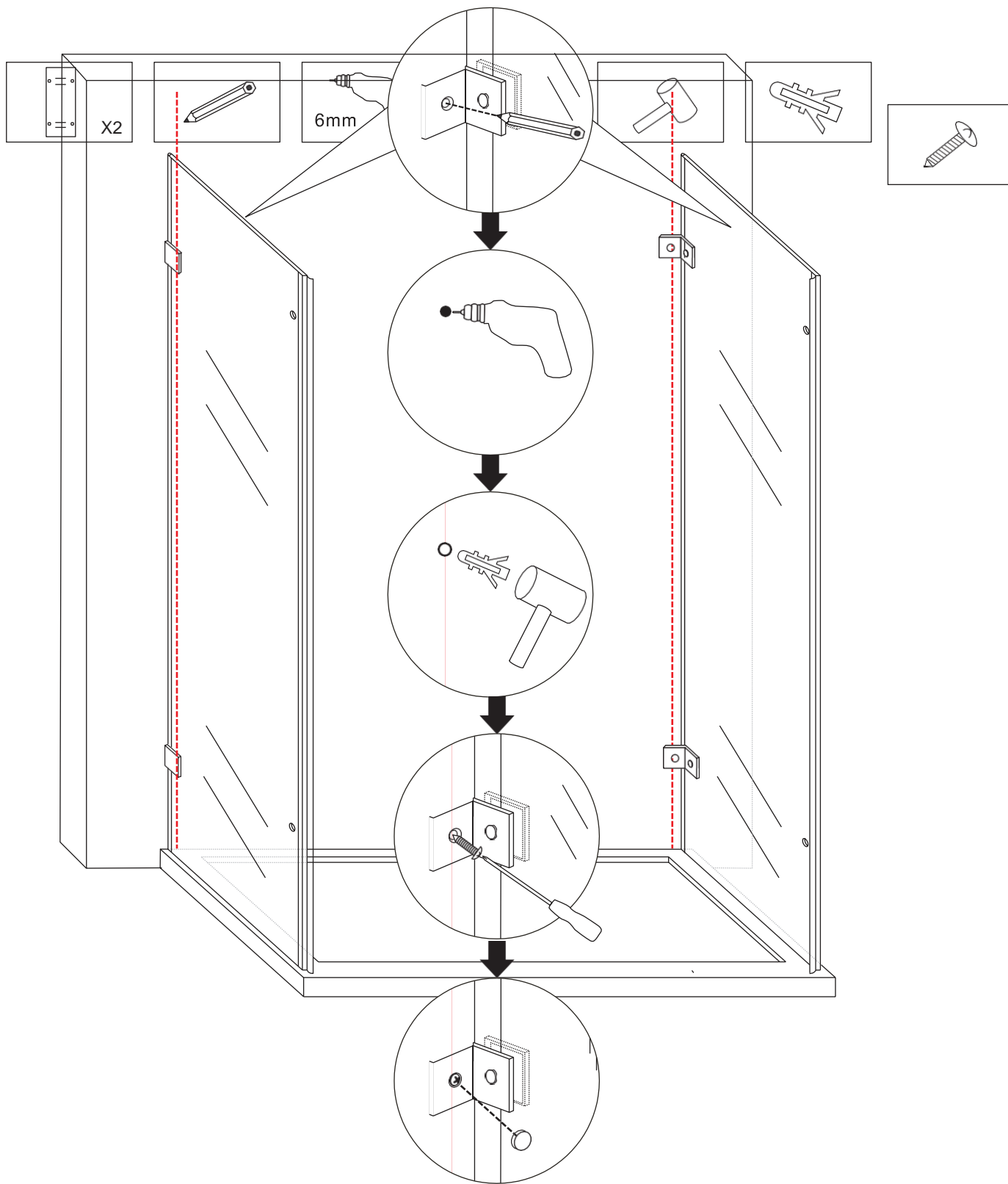

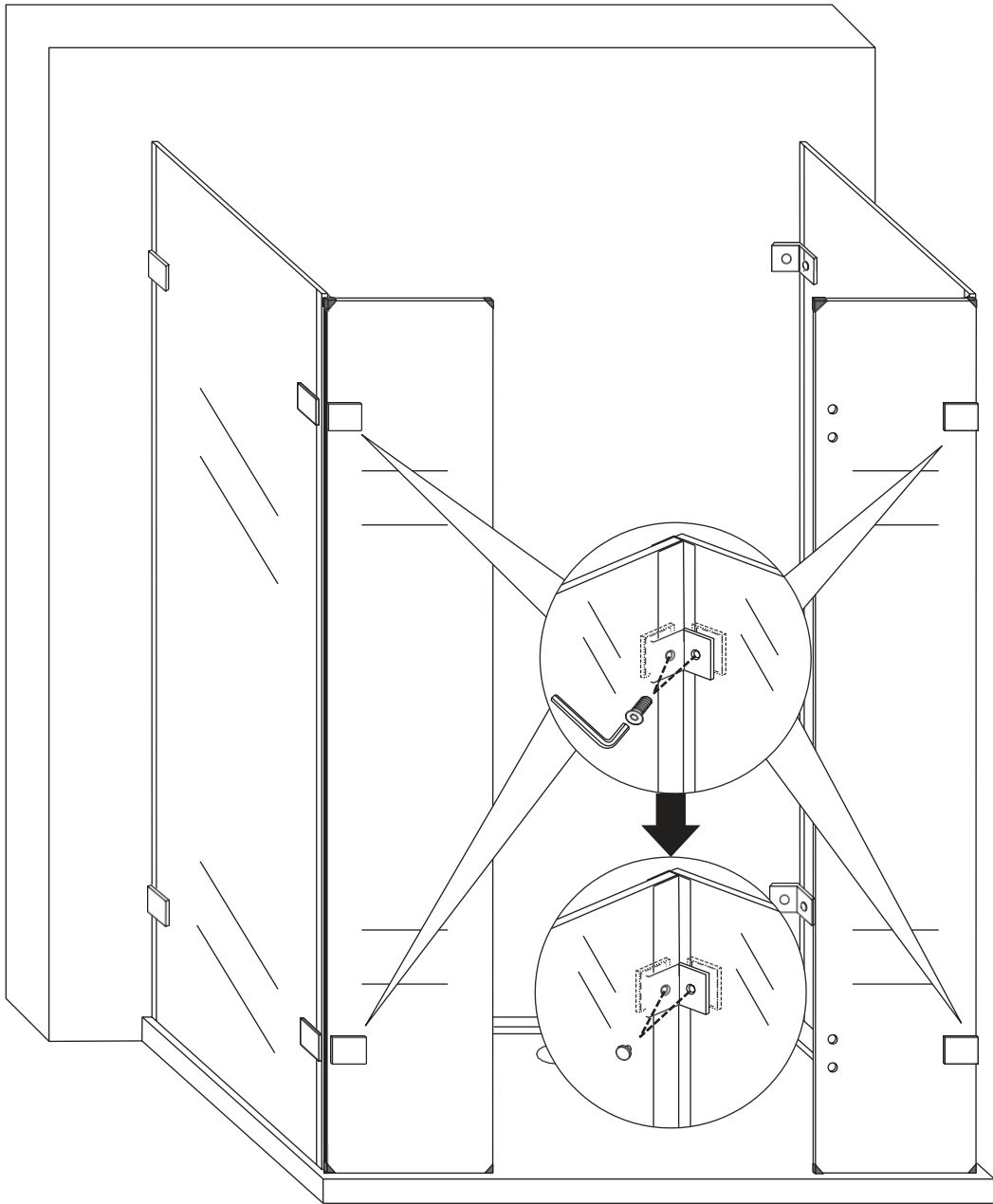
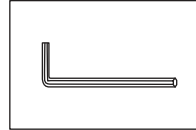
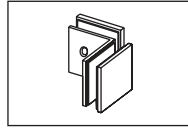
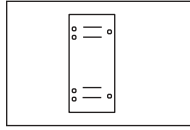
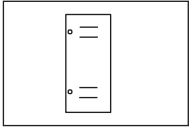

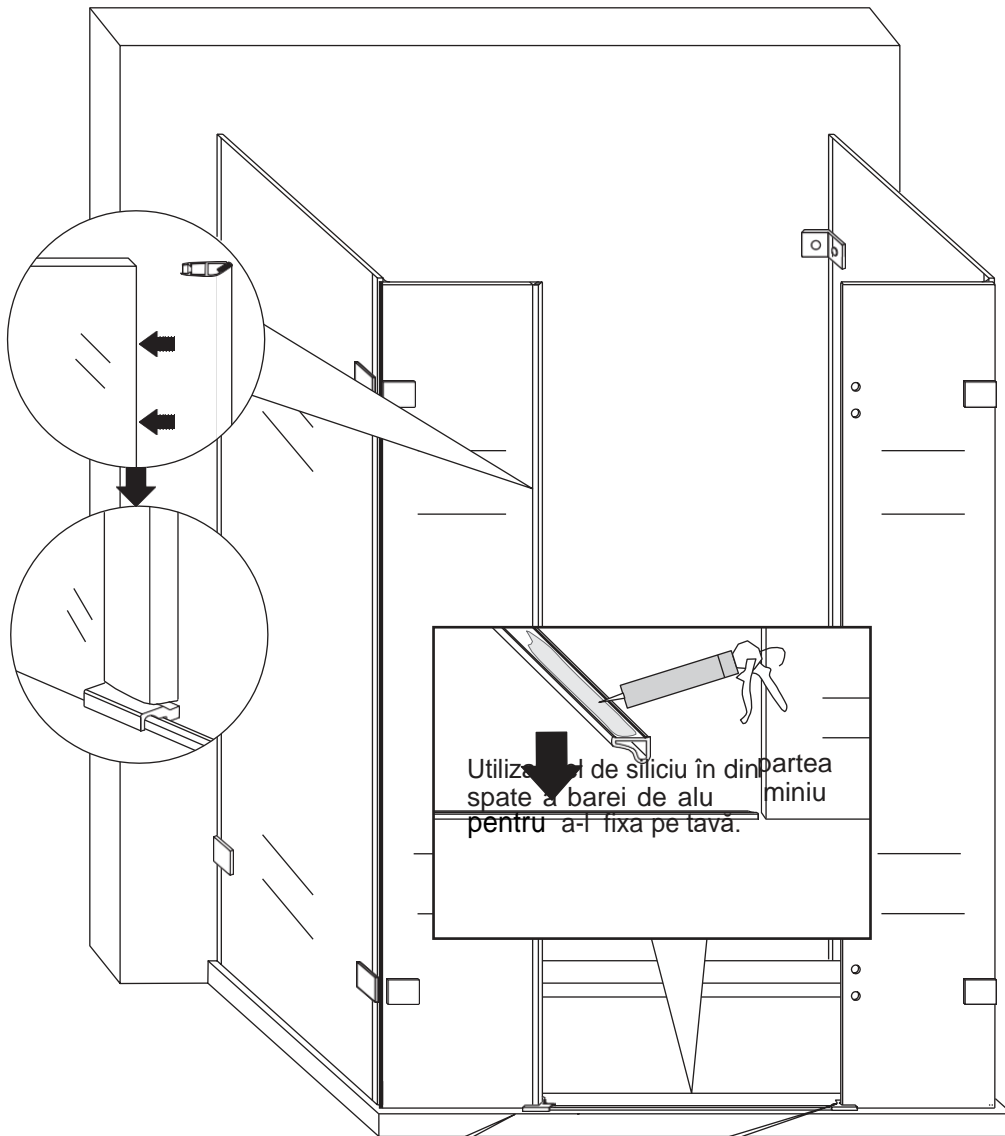
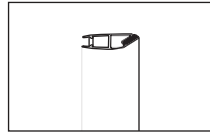
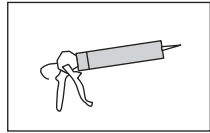
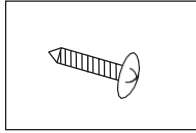
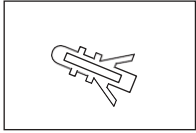
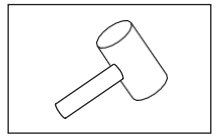
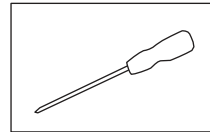
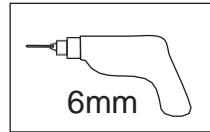
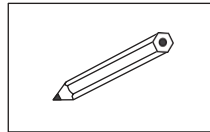
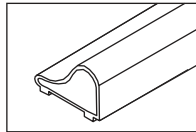
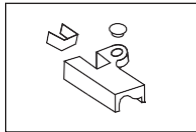

Utilizați un de siliciu în dinpartea
spate a barei de alu miniu
pentru a-l fixa pe tavă.

