

Instrucțiuni de montaj

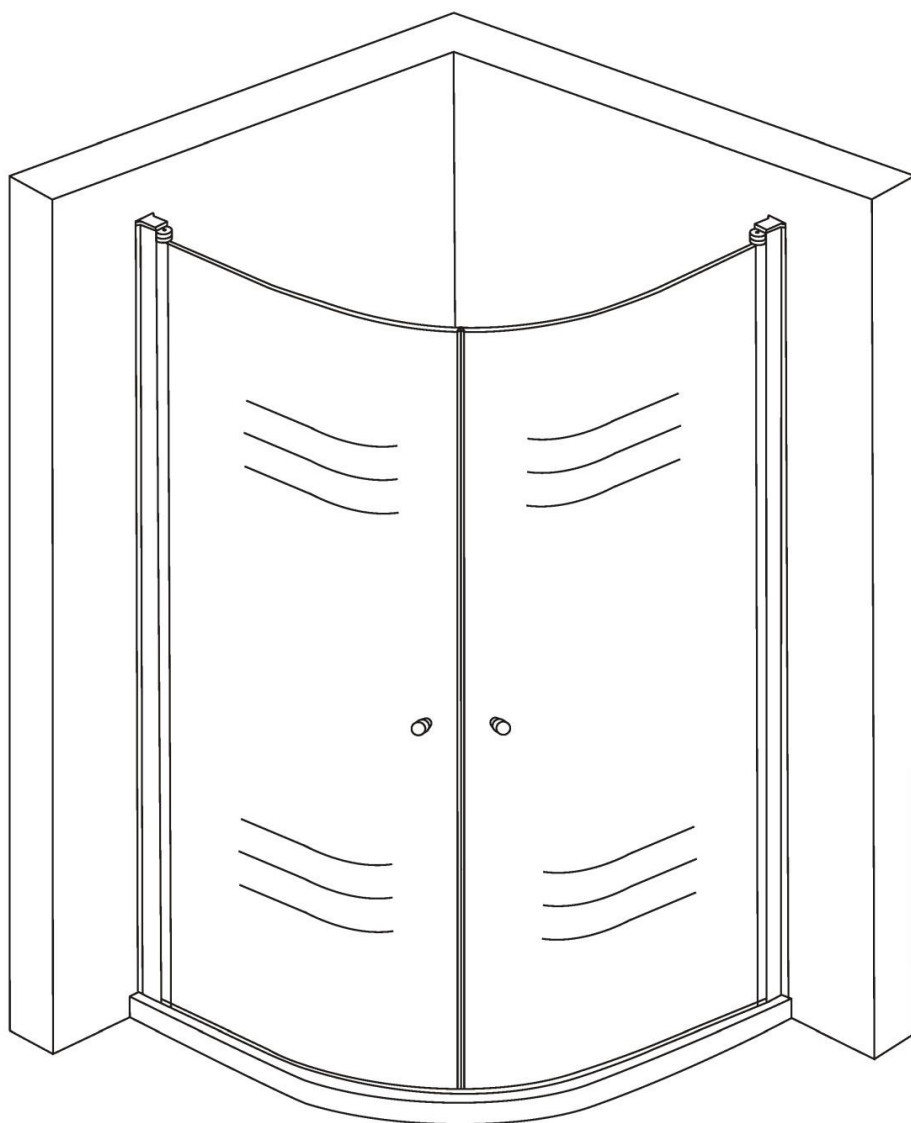

079S

RoHS **CE** ISO9001:2000

Instrument necesar

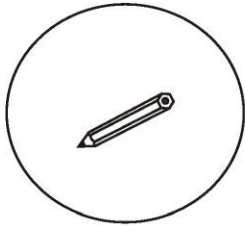

Creion

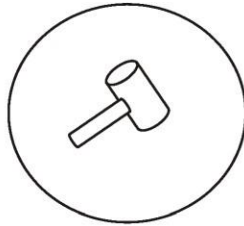

Ciocan de cauciuc

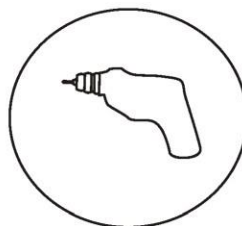

Bormasina

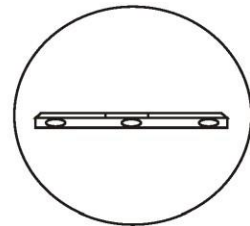

Boloboc

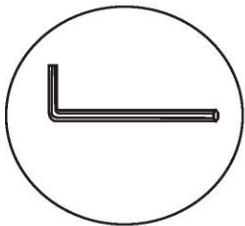

Cheie hexagonală

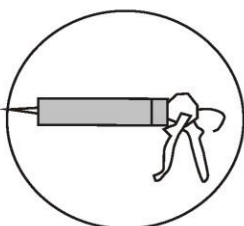

silicon

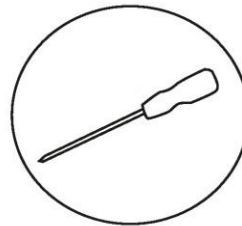

șurubelniță

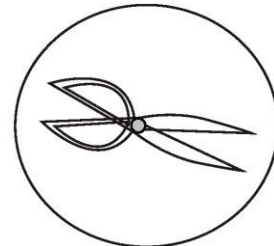

foarfece

Părți

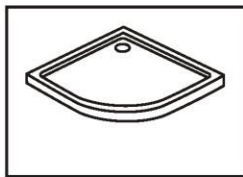

Tray

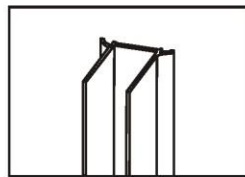

Wall profile

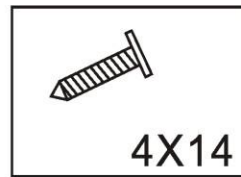

Screw

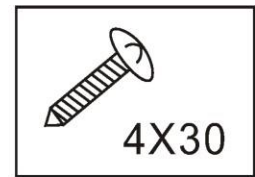

Screw

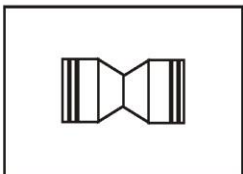

LS-1202

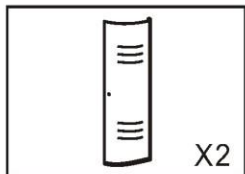

Glass

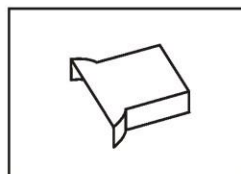

PJ-4643

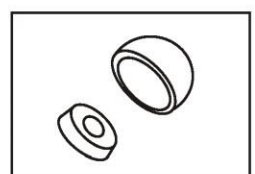

PJ-4553

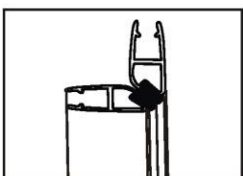

CT-8BMX90

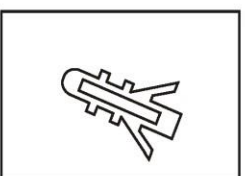

Expand tube

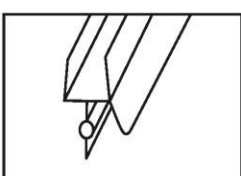

Water-proof gasket

1. Marcati linia de asamblare pentru a instala profilurile de perete

Dimensiuni cabină de duș	1 (L1)	2 (L8)
80 x 80 cm	776 mm	776 mm
90 x 90 cm	876 mm	876 mm

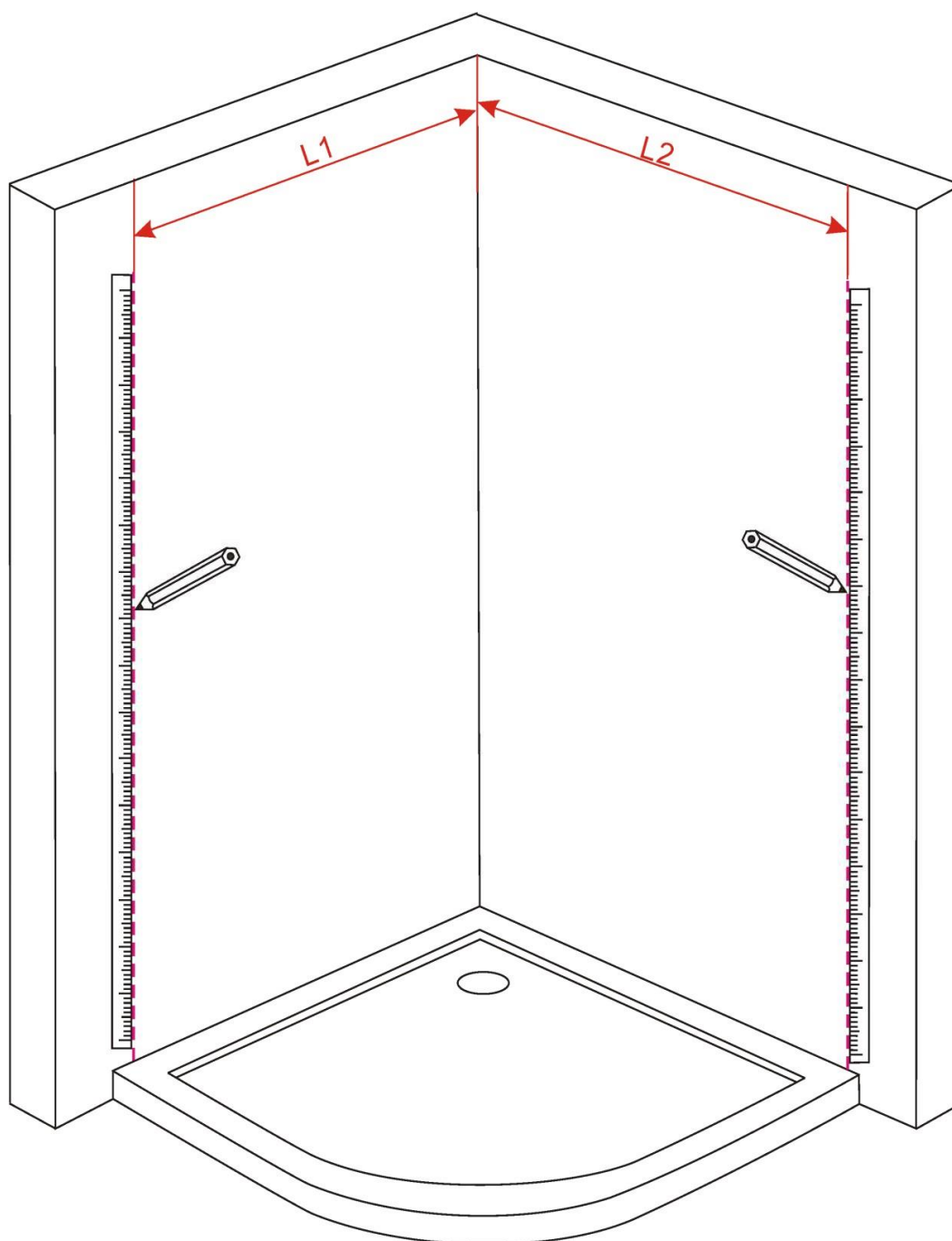

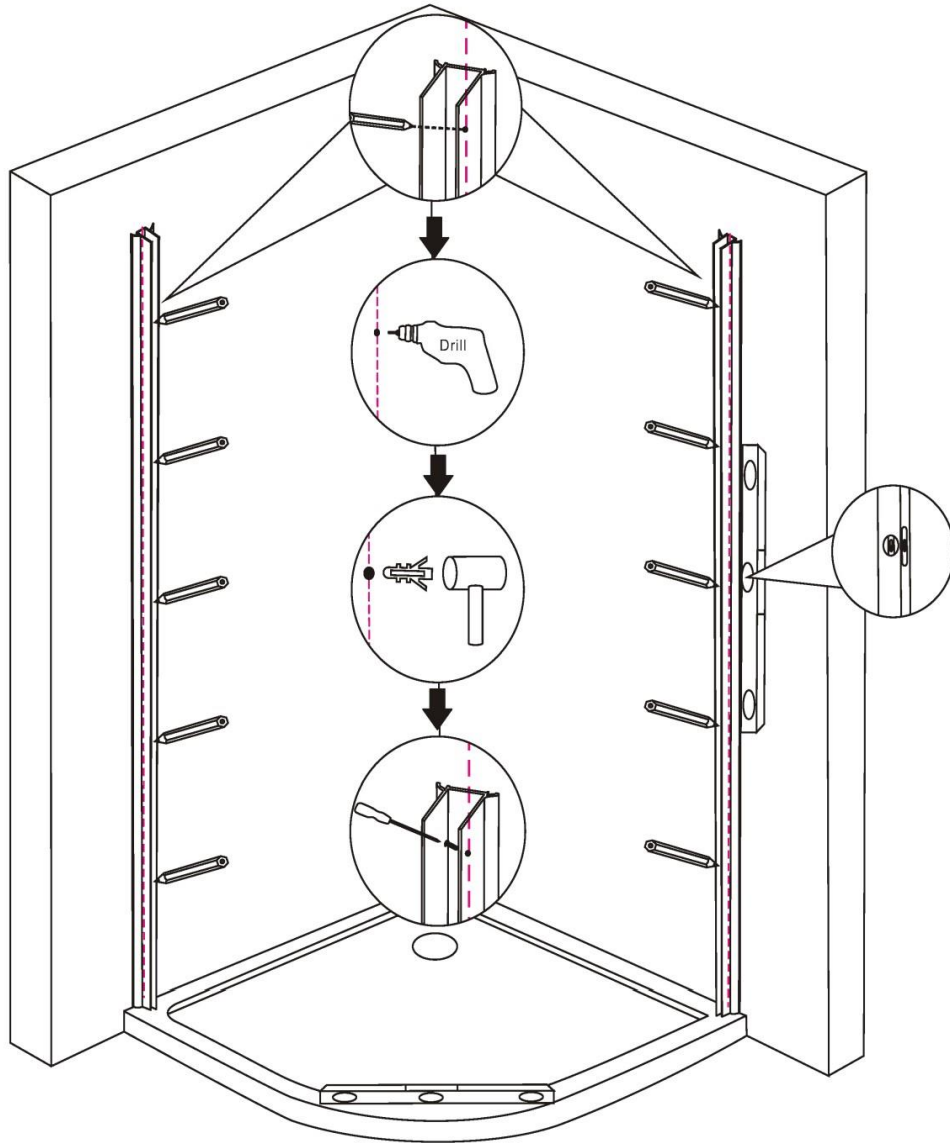
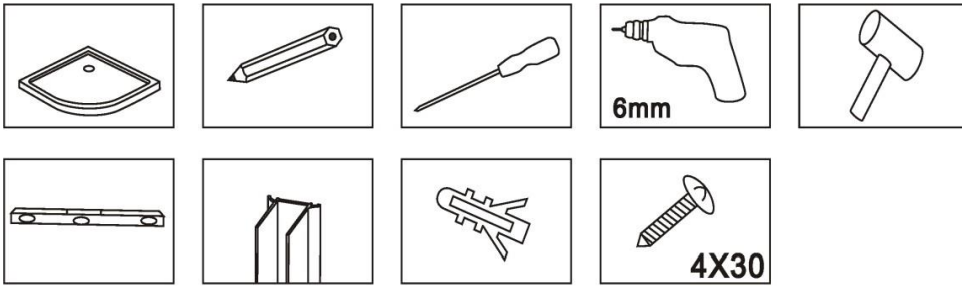

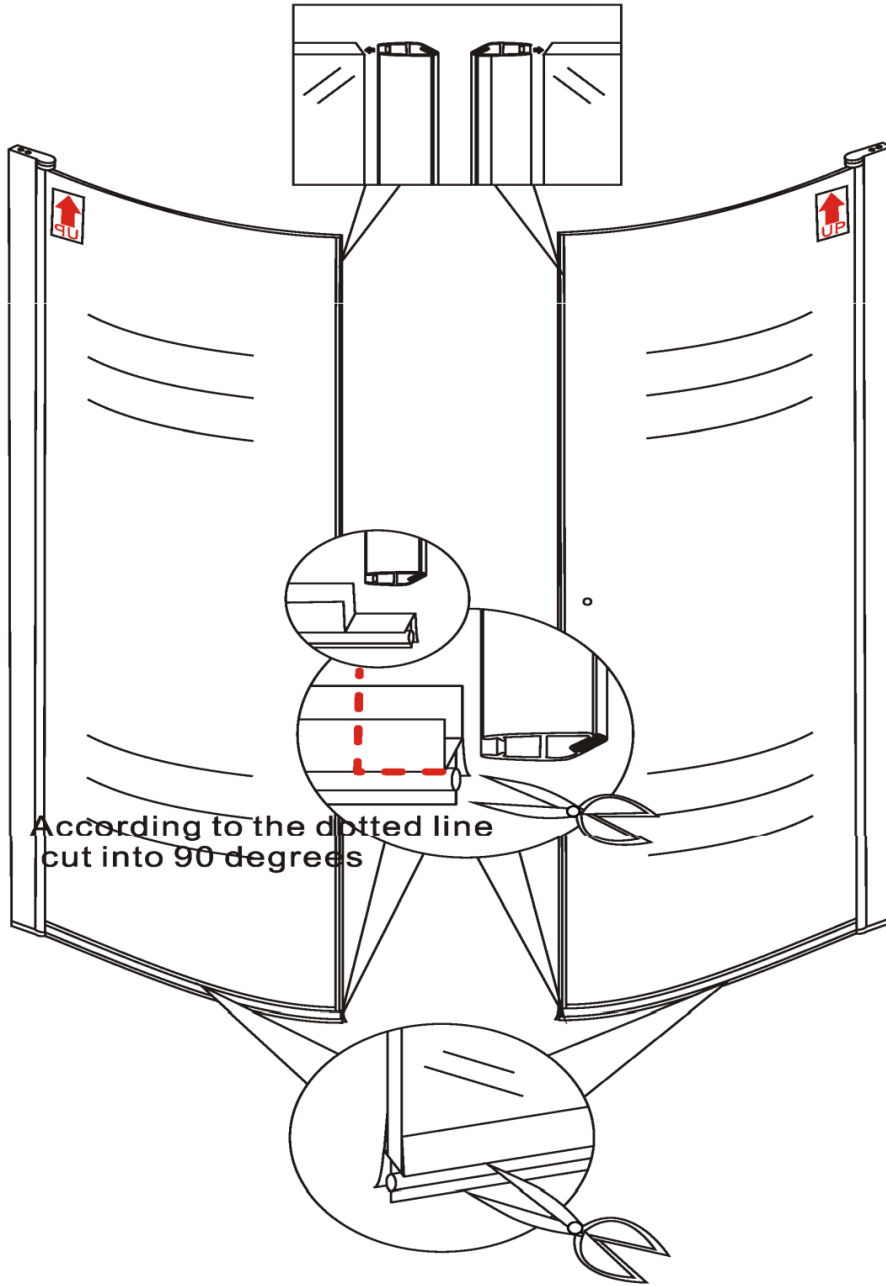

According to the dotted line
cut into 90 degrees

