

Instructiuni de montaj

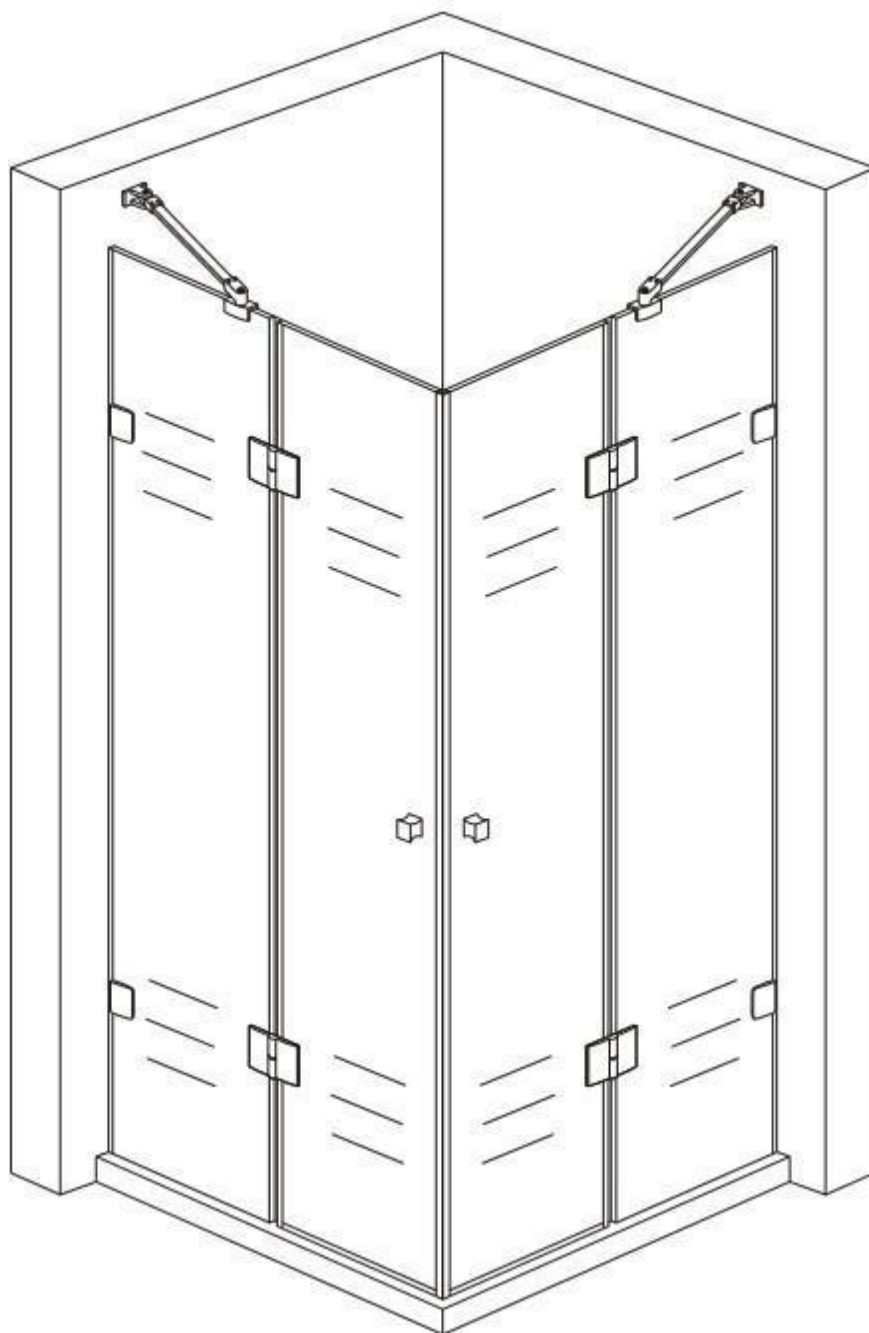

Instrument necesar

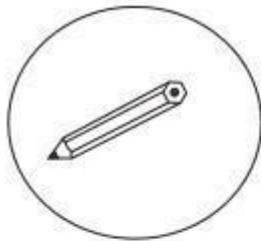

Creion

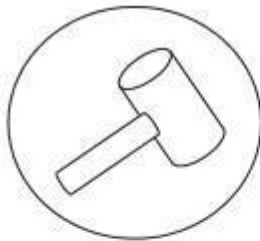

Ciocan de cauciuc

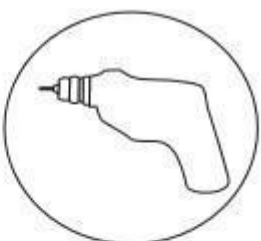

Bormasina



Boloboc

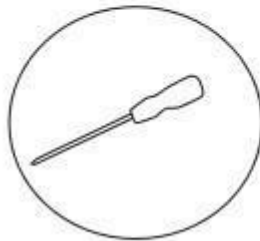

Surubelnita

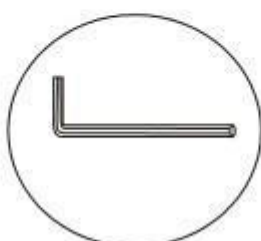

Cheie hexagonala

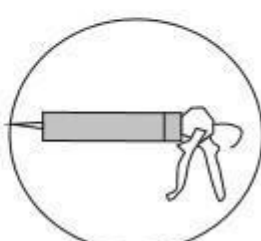

Silocon

Părți

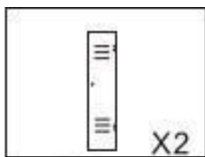

geam

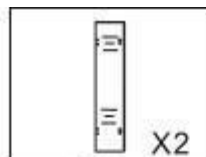

geam

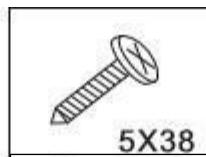

surub

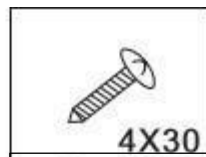

Screw

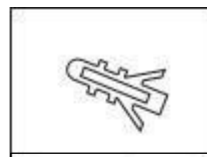

diblu



PJ-4329



PJ-4650

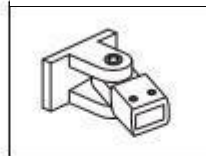

PJ-4149

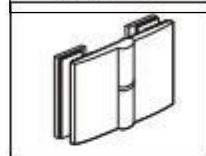

PJ-4026

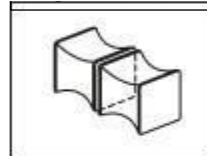

LS-1114



CT-8BMX90

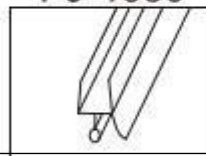

water-profile gasket



LG-2305



PJ-4150

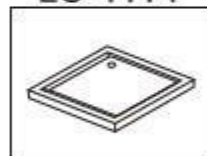

Tray cadita

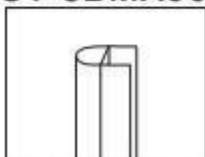

CT-8DSTC



CT-8DST180

Utilizați bolobocul, desenați liniile verticale de instalare în funcție de dimensiunile dvs.

Dimensiune cabina	L1	L2
800X800	745	745
900X750	845	695
900X800	845	745
900X900	845	845
1000X800	945	745
1000X900	945	845
1000X1000	945	945
1200X800	1145	745
1200X900	1145	845
1200X1000	1145	945
1200X1200	1145	1145

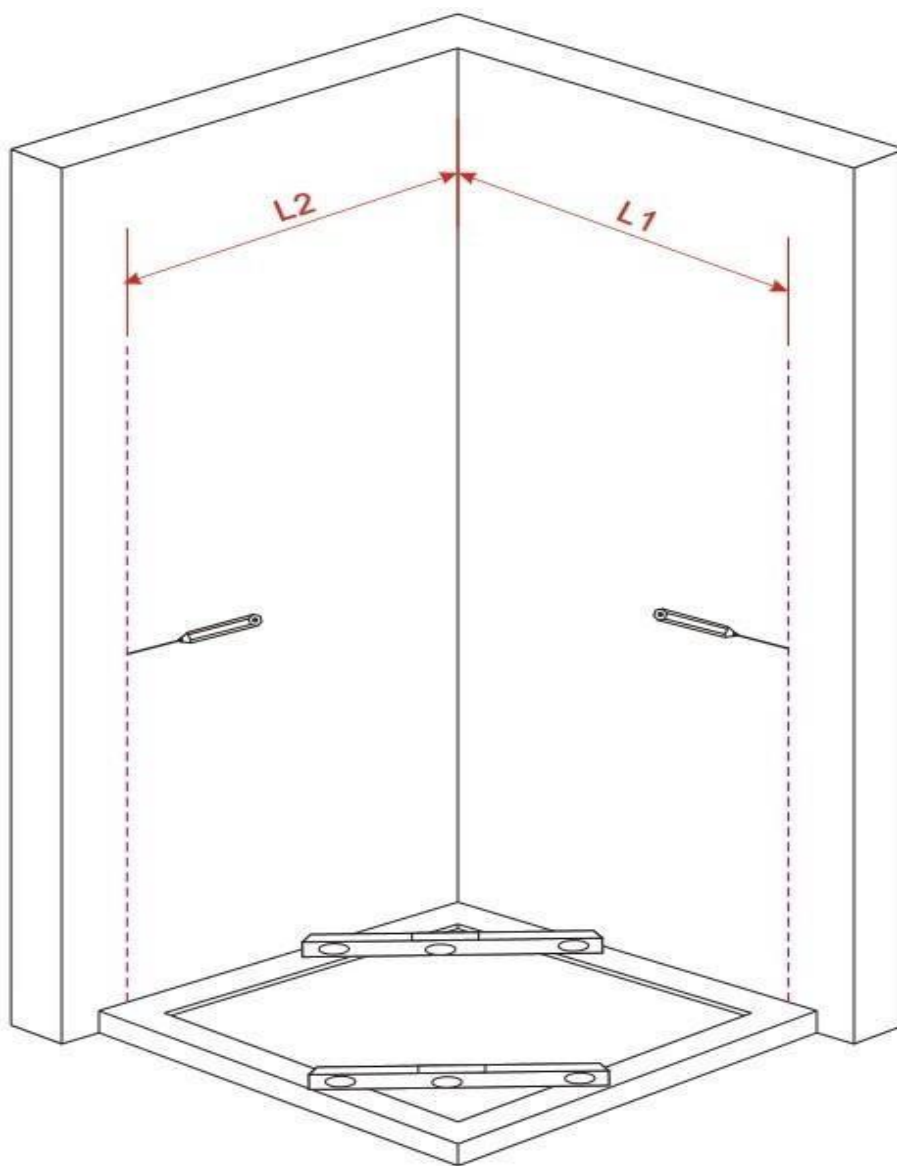

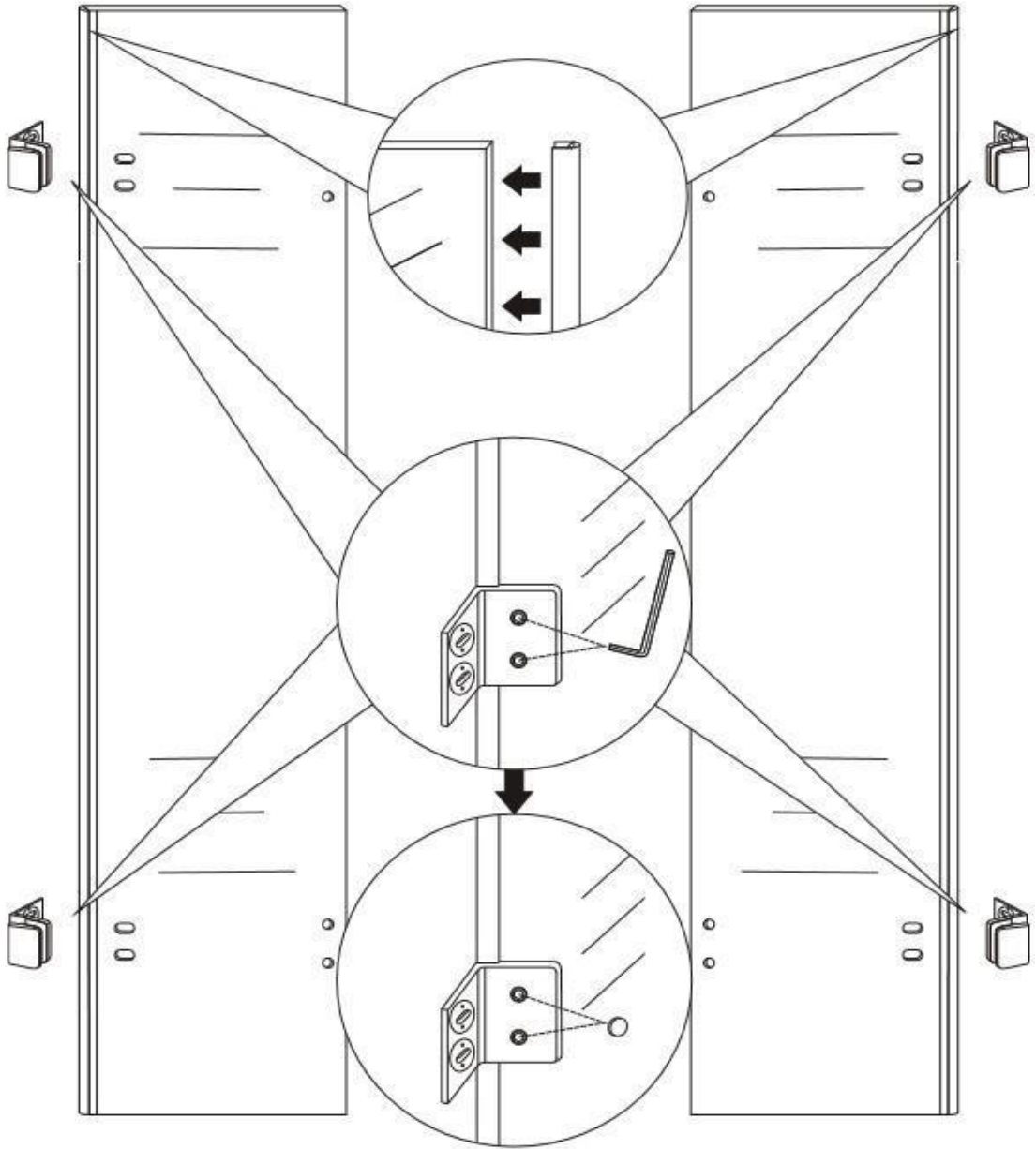
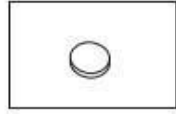
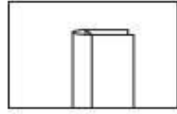
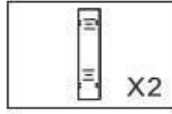

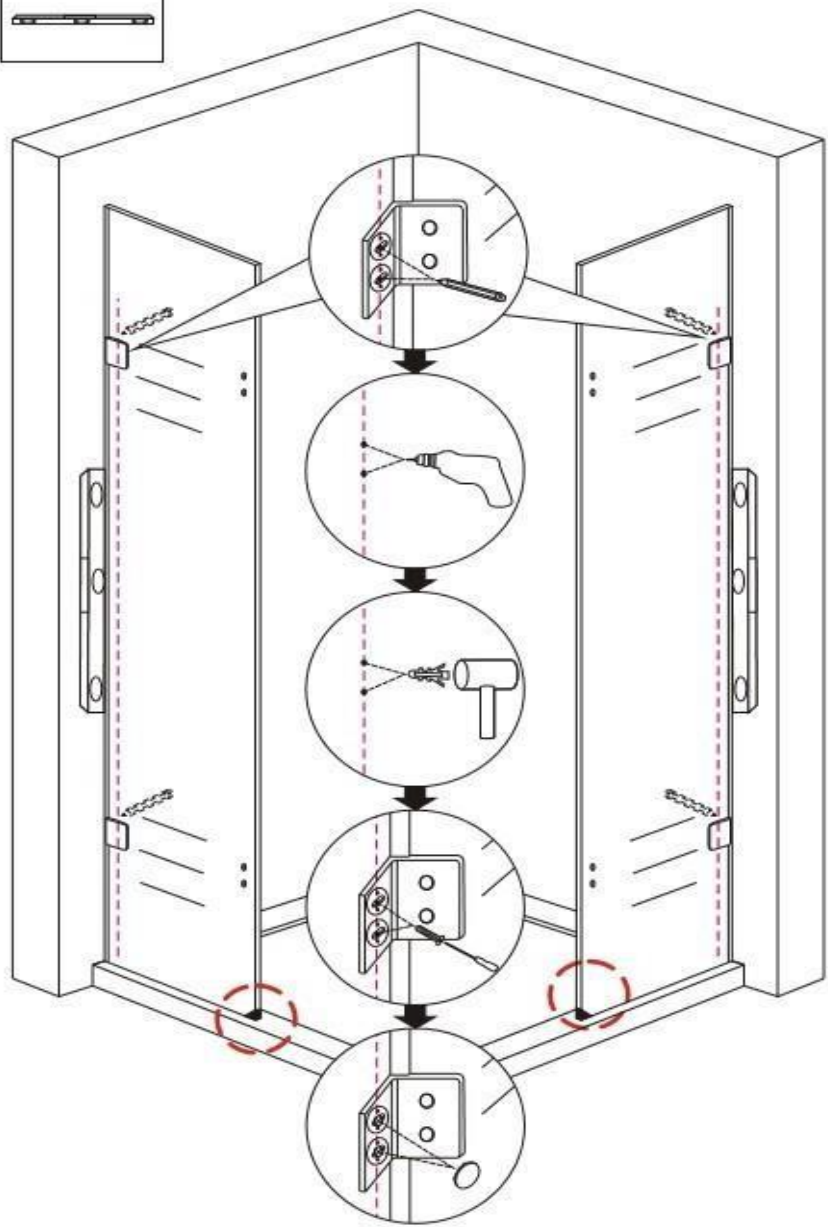
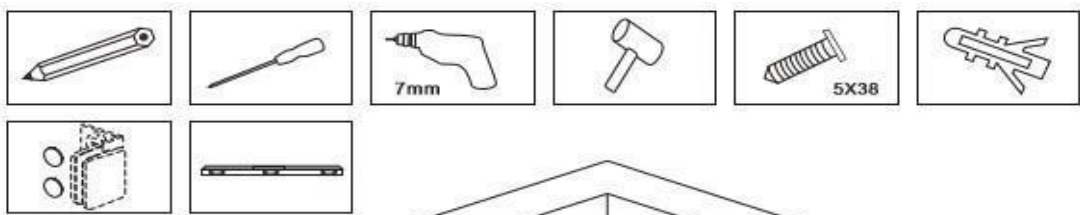

În timpul acestui proces, lăsați protecția de margine pe sticlă



